

COMPONENT LIST

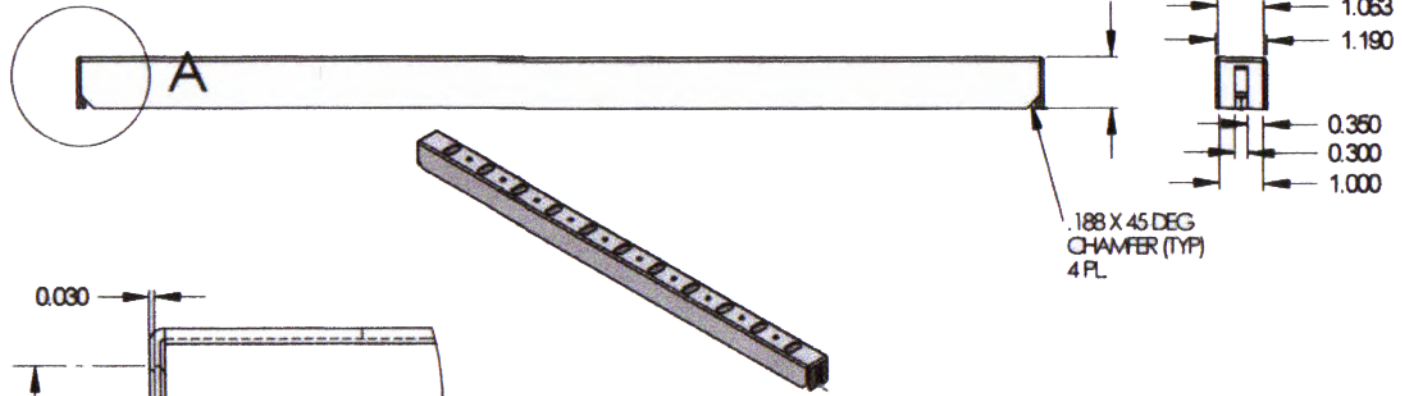

L" DIM.	ITEM	MAKE FROM	DESCRIPTION
		P/N HS 24	
6"	HS 06	" "	CO WIRE .196 DIA.
12"	HS 012	" "	
22-5/8"	HS 24		

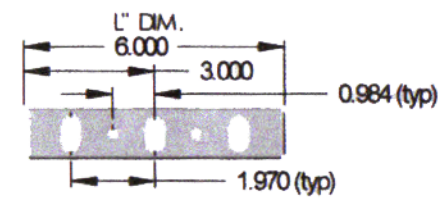
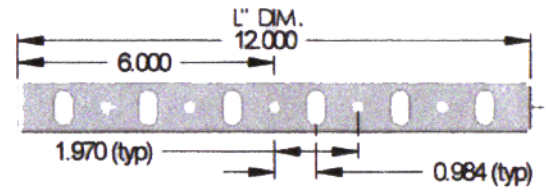
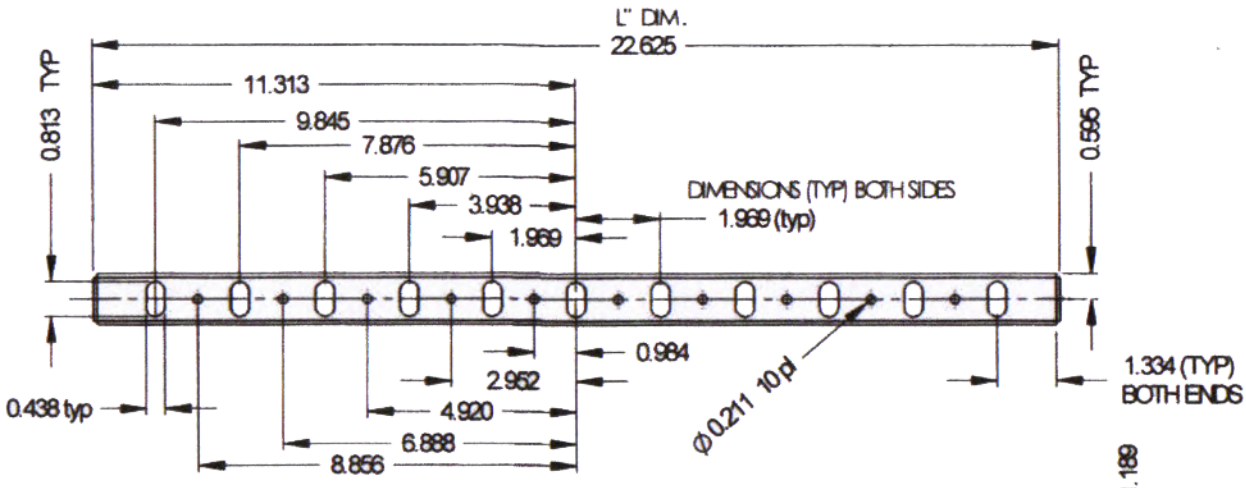

GENERAL NOTES

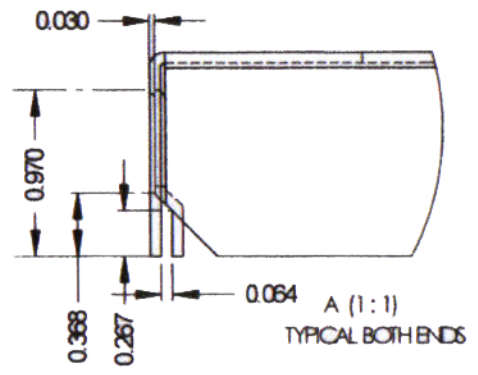
- 1) MATERIAL TO BE COMMERCIAL QUALITY MILL GALVANIZED STEEL PER ASTM A653 & A924 W/ G-60 COATING MIN YIELD = 33 KSI
- 2) DIMENSIONAL TOLERANCES
  - A) GENERAL:  $\pm .030$
  - B) LENGTH:  $\pm .060$
  - C) WIDTH:  $\pm .060$
  - D) HOLE / SLOT LOCATION  $\pm .015$
  - E) ALL ANGLES TO BE  $90 \pm 2$  DEG UNLESS NOTED OTHERWISE
- 3) MATERIAL THICKNESS (NOM): 16 GAGE = .063"



UNLESS OTHERWISE SPECIFIED, DIMENSIONS ARE IN INCHES					DEBUR AND BREAK SHARP EDGES		 ACCESS CABLE TRAYS A Product of 		
REVISION	NAME	CHANGE	DATE				TITLE	HORIZONTAL SUPPORT	
A	AF		3-1-10				DWG NO		HS - 24
								SHEET 1 OF 1	